

AGRIWELD

Operator Manual

Front Linkage Weight Block

1000kg – 2500kg

Single and Twin Toolbox models

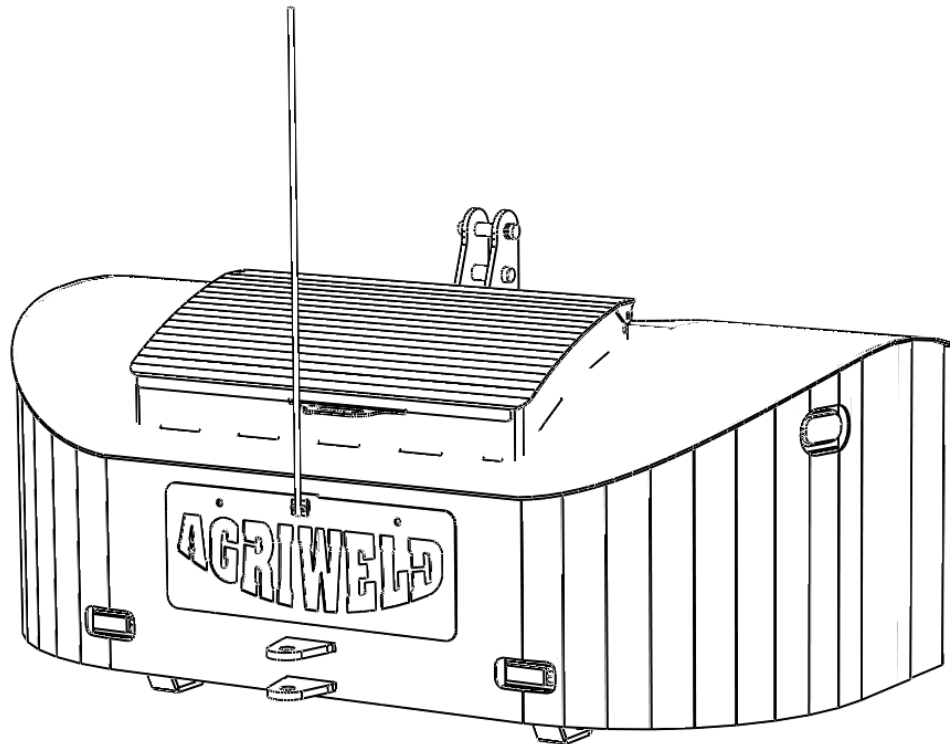

AGRIWELD

Main Street
Garton-on-the-Wolds
Driffield, YO25 3ET
Tel: 01377 259140
Fax: 01377 259141
Email: sales@agriweld.co.uk
www.agriweld.co.uk

CONTENTS

Page 3	Summary
Page 4	General Safety & Qualifications and Training
Page 5	Further Safety & Special Safety Instructions
Page 6	Important Maintenance & Important Maintenance for Water Variweight Option
Page 7	Risks of Overloading
Page 8-9	Risk Assessment
Page 10	Large Central Toolbox Assembly
Page 11	Twin Toolbox Assembly
Page 12	Toolbox Dimensions
Page 13	Weight Dimensions
Page 14	Parts List
Page 15	Connecting your LEDs
Page 16	Connecting your LEDs continued...
Page 17	Warranty
Page 18	Stickers
Page 19	CE Declaration of Conformity

Summary

The Agriweld Weight is a multipurpose implement and is designed to fit any tractor by use of a front linkage. Designed and manufactured by Agriweld in Great Britain, it has several main uses;

As a ballast weight the Agriweld Weight adds 1000kg - 2500kg to the tractor front end and assists in utilising the full power of the tractor whilst in the field and balances the tractor whilst moving heavy loads on the road.

The lower and wider curved profile of the Agriweld Weight is much safer than some models available. It is clearly visible to the driver, down both the near and off side front of the tractor. It is fitted with a central, vertical marker, which is also a constant reminder to the driver that the Weight is on the front. This marker can also be used as a centre marker in the field.

The integral toolboxes are a good size and can be used to store tools, wearing parts etc., and aid the safety of the driver in providing a place to store clutter from the cab floor.

General Safety

This manual must be provided to all persons concerned who will be involved with the setting up, operation, maintenance and use of the tractor and Agriweld Weight. It must be available at all times.

If important safety instructions are not complied with, it can lead to the risk of injury to you and others as well as damage to property and the environment.

NON-COMPLIANCE WITH SAFETY INSTRUCTIONS CAN LEAD TO WARRANTY CLAIMS BECOMING INVALID

Qualifications and Training

- Only personnel with the appropriate licence is authorised to use this machine.
- Statutory minimum age limits must be observed and reliable personnel only should perform maintenance/work on this machine.
- Persons undergoing training or instruction or taking part in a general training course should only use this machine under direct supervision of an experienced and trained person.
- The use of spare parts, accessories and ancillary equipment not supplied or approved by Agriweld could have detrimental effects to the construction or functions of the Agriweld Weight.
- Agriweld shall not be responsible for any damage caused by the use of spare parts or accessories and ancillary equipment not supplied or approved by Agriweld.
- The operator must be aware of their responsibilities with regard to observing traffic regulations. The operator must have the authority to refuse instructions issued by third parties which contravene safety.
- Any conversions or modifications to the machine may only be carried out after prior consultation and written confirmation from Agriweld.

Further Safety

- Any warning signs/instructions on the machine provide important information and must be observed.
- Ensure that you are familiar with the equipment, controls and functions before starting work.
- Check around the machine for any noticeable damage or missing parts before starting work.
- It is advisable that the operator wears close fitting clothing to avoid the risk of snagging and trapping.
- Ensure that you watch out for wandering individuals (particularly children!).
- Always match your speed to the conditions and legal speed limits. Observe and respect traffic regulations when using public roads.
- Remember to take into account the size of any attachments to the tractor you may have and be aware of the sideways forces acting on the machine when turning and negotiating corners. Always ensure adequate all round visibility.

Special Safety Instructions

- Take extra care when hitching up or un-hitching the weight to/from the tractor. Be aware of what is under the weight (such as your feet) before dropping it off.
- Ensure that the tractor's hydraulic system is in full working order.
- Never allow any person to stand between the tractor and the weight during connection or at any time unless the tractor is secured against rolling away by use of a parking brake and/or wheel chocks.
- It is forbidden to allow any persons to ride or sit on the weight at any time. Observers should maintain a safe distance when machine is in use.
- When performing any adjustments to the machine the tractor engine must be switched off to prevent the hydraulics from operating.
- Ensure that any items stored in the toolboxes are secured by closing the lid.
- The driving characteristics of the forklift/loader/tractor are influenced and altered by the attachment of mounted machines and it is important to ensure adequate steering and braking ability as required.
- The towing clevis is intended for light use only. E.g.: for pulling a furrow press out of a corner using a chain. It is more of a chaining point not an actual towing point and is NOT suitable to tow a trailer down a public road when in use on the rear linkage. The towing clevis can be used for towing lighter

loads round the yard, however, it is not a load tested item and so cannot be guaranteed safe for use on public highways and is to be used for towing at own risk.

- Take care when attaching weight to tractors 3-point linkage as the operator could trap their fingers in the linch pins.

Important Maintenance

It is important to check all pins for wear and ensure that none show significant signs of wear or damage. Keep the weight clean at all times.

When machines are going to be parked up for the winter months, correct storage methods are an important part of protecting the Agriweld Weight to ensure it has no problems. When you have finished work with the machine, the Weight should be cleaned down and washed off and stored inside to protect the paint work.

Water Variweight Option

IMPORTANT MAINTENANCE

Fill with anti-freeze or empty of all water during the winter months to prevent damage to the metal casing.

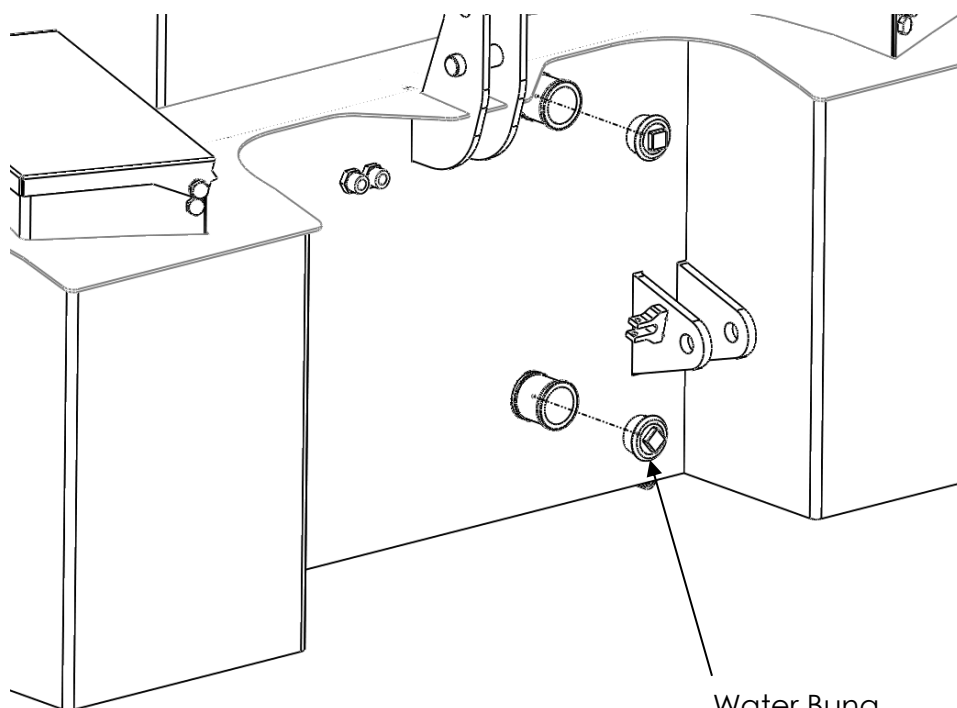

Water Bung
Part No. BFFA32

RISKS OF OVERLOADING

It is your responsibility to check the maximum load capacity of your tractor chassis/front linkage, before ordering your ballast weight to ensure that you do not exceed the recommendations advised by the tractor/front linkage manufacturer.

Agriweld will accept no responsibility for damage or injury occurred by attaching a ballast weight that exceeds the maximum capacity advised by the tractor/front linkage manufacturer.

It is important to ensure any additional weight imposed when carrying tools/spares stored within the toolboxes is also accounted for and the additional weight does not exceed the overall maximum capacity of the tractor's linkage/chassis.

Weight Block Risk Assessment

Date risk assessment completed: Reviewed October 2018 – to review again in 1 year or sooner if required
 Organisation name: Agriweld Ltd

MACHINERY TYPE: Ballast weight 500kg - 2500kg

Description: An attachment for the front or rear of a tractor as a counter balance for the tractor when using other attachments. [Attaching via a front linkage or bolster fitting with various weights ranging from 500kg – 2500kg.](#)

<i>What are the hazards?</i>	<i>Who might be harmed and how?</i>	<i>Risk evaluation Levels 1-5 (1 = Low risk, 5 = High risk)</i>	<i>Precautions in place</i>	<i>Further action required/notes?</i>
Weight block detaching causing crushing/trapping	Operators and bystanders if weight falls unexpectedly or whilst attaching to tractor linkage, trapping limbs or being crushed	2	Feet fitted to the base of the weight assists preventing crushing/trapping injuries to limbs if weight becomes detached and falls. Operator manual stipulates information on the correct use, capacity and to check connection to the tractor prior to use each time for signs of damage or missing parts that could be responsible. Regularly check/replace linkage and lynch pins if deemed faulty or missing. Note in manual references not standing in between the tractor linkage and the weight during attachment/detachment and at all times.	Continue to ensure every customer receives an operator manual and review/update all safety measures as required. Online version of manual available on Agriweld website at all times.
Lack of operator training/ignorance causing accident	Operator and bystanders	3	A bright yellow warning sticker is attached to the weight, to alert operators to read the operator manual. Operator manual states all operators of the tractor must have a valid licence/experience.	Maintain the availability of the operator manual on line as well as paper copy so that it can be available 24 hours a day if required.
Worn parts and non-maintained attachments can become loose on connection	Operator and bystanders. Aged or worn linkage parts causing poor connection on tractor and coming loose	2	Notes in the operator's manual inform operators to keep the weight clean and inspect prior to each use noting any areas of concern/damage, missing parts and wear. Operator manual states not to use the weight if there are any parts damaged or missing.	Operator manual advises regular maintenance checks

Weight Block Risk Assessment

<i>What are the hazards?</i>	<i>Who might be harmed and how?</i>	<i>Risk evaluation Levels 1-5 (1 = Low risk, 5 = High risk)</i>	<i>Precautions in place</i>	<i>Further action required/notes?</i>
Failing LED lights & damaged wire/cabling – potential collision on highways	Operator & general public/other road users by non-maintenance	2	The LED wiring loom is correctly installed and clipped out of the way of catching/snagging wires and is connected up to a junction box. Operators are advised to use the correct tools/PPE to perform any LED repairs/replacements and follow instructions contained in the operator manual.	Note in LED section of operator manual about regular checks to ensure working correctly before use in the dark
Knocks to individuals-wandering into the path of the weight whilst attached to tractor.	Bystanders walking directly into the weight by not paying attention when around the tractor and weight	1	Centre marker rod reminds operator it is attached to front of tractor Operators advised to be aware of wandering individuals	See safety notes in operator's manual
Malicious damage	All	1	It is possible that malicious damage can be caused e.g removing linch/linkage pins, damage to brackets or cutting wires for the LEDs Operator manual states weight block should be checked over prior to first use which would alert the operator of any missing or damaged parts	See notes in operator's manual
Overloading tractor chassis/front linkage- causing failure of tractor linkage	Operator and general public	2	Initial sales enquiry picks up any unusually heavy requests for front linkage mounted models. For bolster/direct chassis mounted models, sales staff are particularly careful with requested weights. Anything unusual is referred to design for approval or rejection and anything detrimental/unsafe is refused. Operator manual states that riding or carrying anything on the weight whilst connected is prohibited.	Risk of overloading section listed in operator's manual

Large Central Toolbox Model Assembly

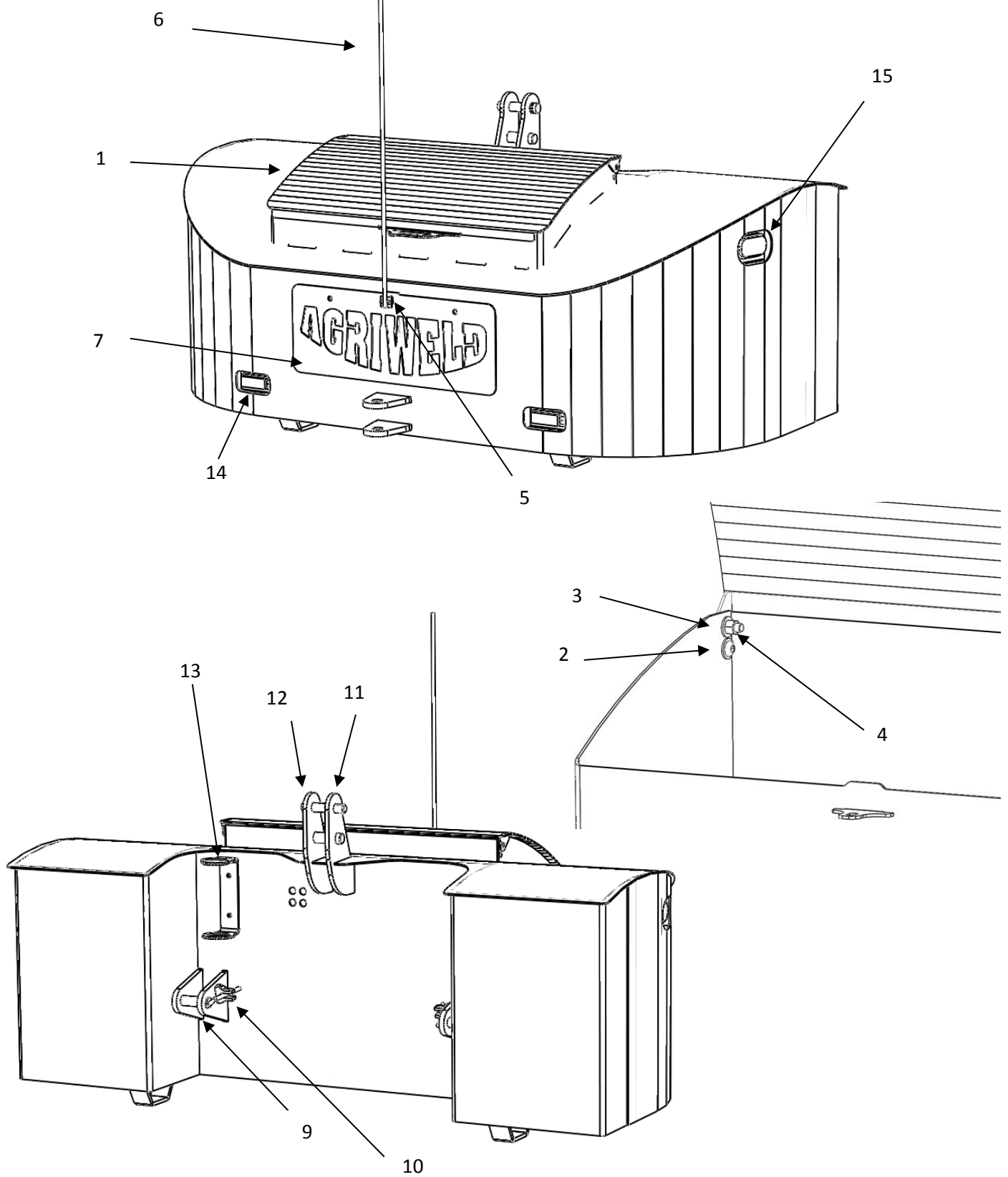

Twin Toolbox Model Assembly

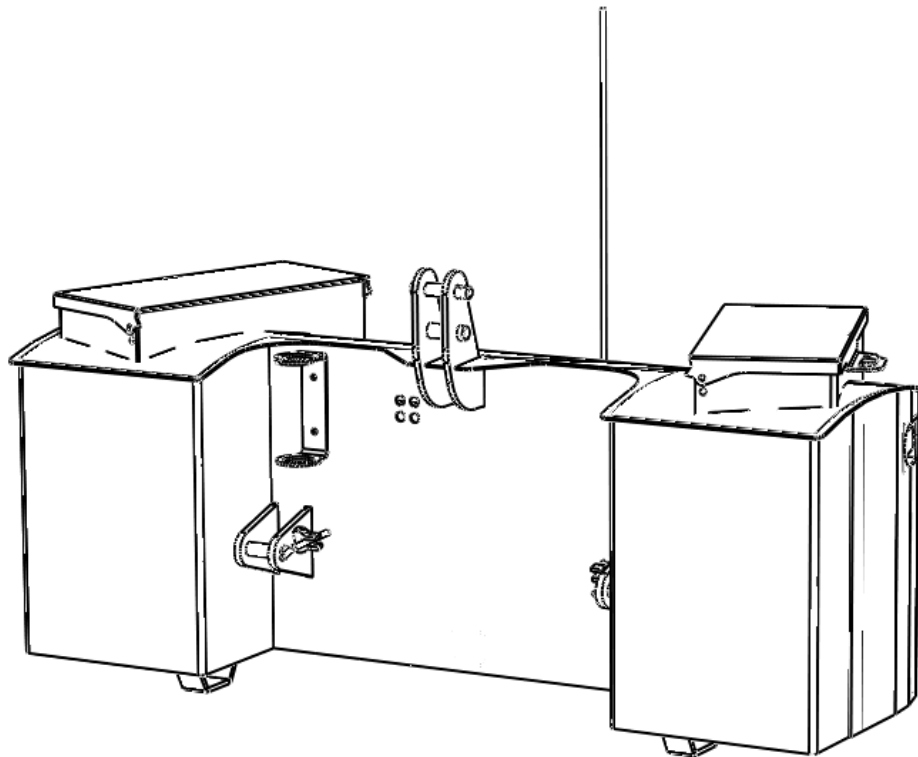
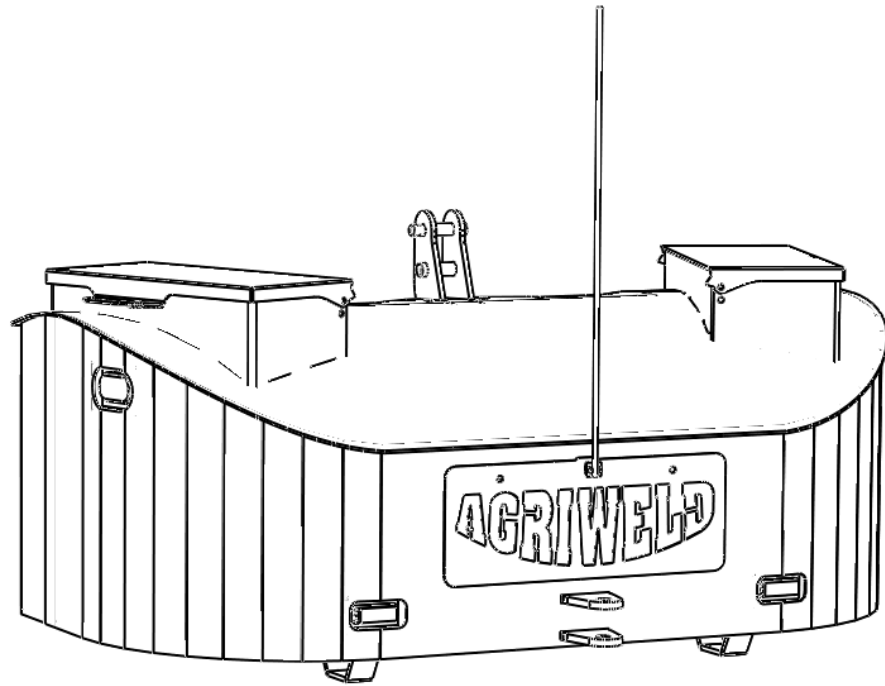

Toolbox Dimensions

Twin Toolbox

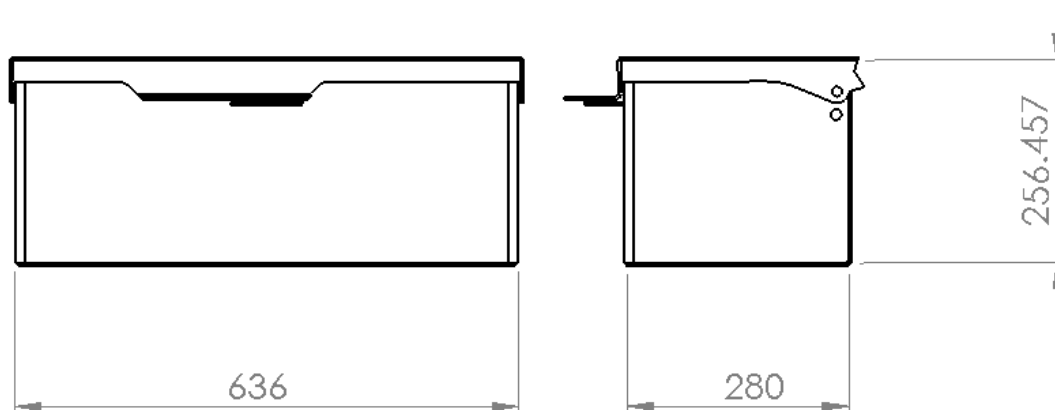

Large Central Toolbox

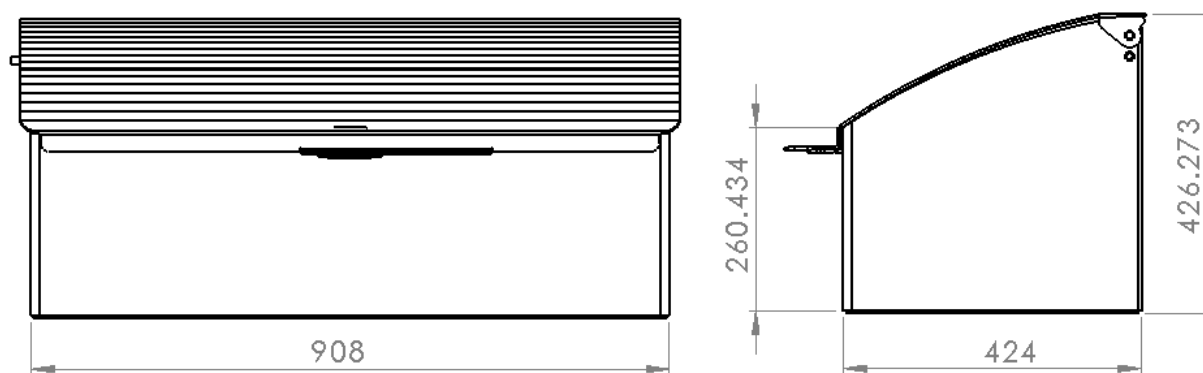

Weight Dimensions

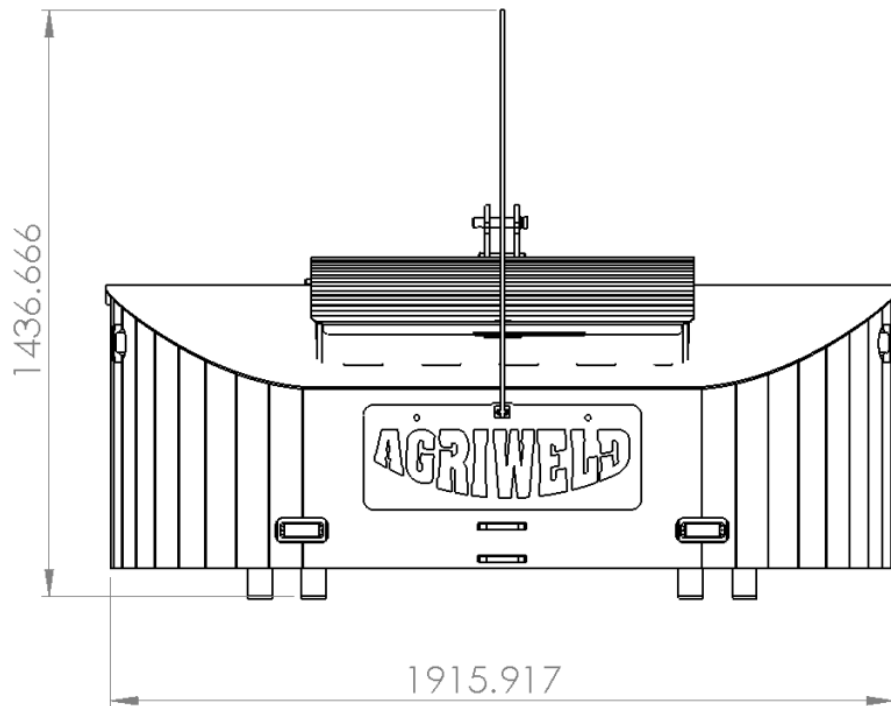

Please note: 2500Kg model is
100mm taller than dimensions
shown

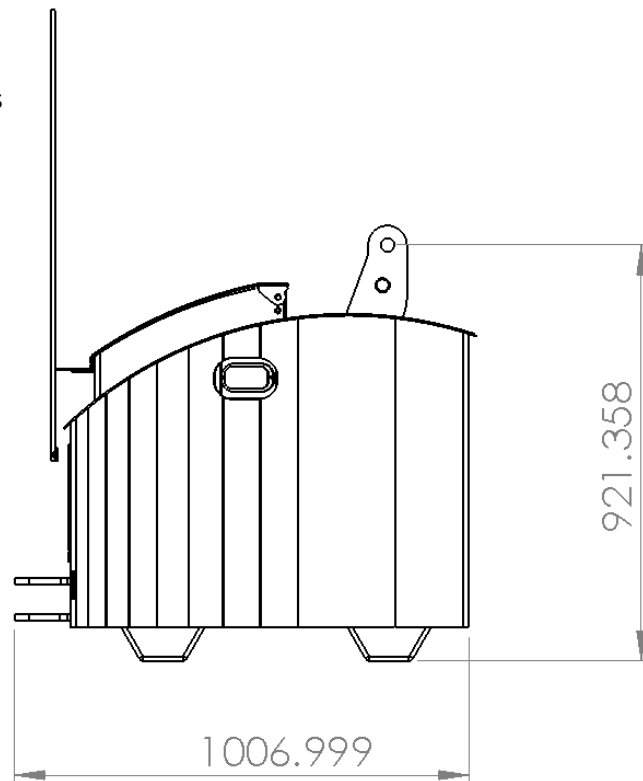

Parts List

Item Number	Part Number	Description	Quantity per Machine
1	WBT_0404	Tool Box Lid	1
2	M12 x 45	Lid Bolts	4
3	M12 Flat Washer	-	12
4	M12 Nylock	Nut	4
5	SP110APPDPAS	Pipe Clamp Kit	1
6	BRIGHT_ROD	Reflective antenna	1
7	AGR_LOGO	Agriweld logo	1
8	M12 x 35	Logo bolts	2
9	Z428.145	Lower Link Pin	2
10	LP6Z	Lower Linch Pin	2
11	Z325.095	Top Link Pin	1
12	LP11Z	11mm Linch Pin	1
13	AWGGH	Grease Gun Holder (optional)	1
14	LT363	Amber Flashing LED	2
15	LT377	White LED	2

CONNECTING YOUR LEDS

If you have ordered amber flashing LED side marker lights with your weight block, you will need to supply and fit the relevant 12-24V electrical plug to suit the connection to your tractor.

Please check that your LEDs are working correctly before use in the dark and especially when in use on public roads. Agriweld will accept no responsibility for damage that has occurred due to lack of maintenance checks.

WHITE LED SIDE MARKER LIGHTS FITTING INSTRUCTIONS

To connect your white LED side marker lights you will need to wire them up to a relevant 12-24 V electrical plug, suitable for your tractors electrical supply.

BLUE WIRE = EARTH (NEGATIVE -)

BROWN WIRE = LIVE (POSITIVE +)

AMBER LED3DV FLASHING MARKER LIGHTS:

The amber flashing LED side marker lights are set to pattern PA1 before delivery. If you wish to change this, you will need to work your way down the list of patterns following the instructions below before fitting the plug and connecting to the tractor.

1. Using the **GREY** wire to make the change you will need a 12V battery on hand to alter the flashing pattern.
2. Connect the **BROWN** wire to Live (**+POSITIVE**) on the battery.
3. Connect the **BLACK** wire to Earth (**-NEGATIVE**) on the battery.
4. Touch the **GREY** wire once to Earth (**-NEGATIVE**) which will produce the next pattern in the sequence.
5. Keep touching the **GREY** wire in this way until the desired pattern is achieved.
6. When happy you can fit your 12-24V plug using only the **BROWN** LIVE (**+POSITIVE**) wire and **BLACK** Earth (**-NEGATIVE**) wire.
7. Cut excess **GREY** and **YELLOW** wires down to within the sheath to prevent further contact.

Connecting your LEDs continued...

Flashing modes

Pattern Number	Pattern	Synchronise	Alternate
PA1	Single Alert 150 – Phase 1	✓	✓
PA2	Single Alert 150 – Phase 2	✓	
PA3	Single Alert 75 – Phase 1	✓	✓
PA4	Single Alert 75 – Phase 2	✓	
PA5	Single Alert 375 – Phase 1	✓	✓
PA6	Single Alert 375 – Phase 2	✓	
PA7	Single Flash 150 – Phase 1	✓	✓
PA8	Single Flash 150 – Phase 2	✓	
PA9	Single Flash 75 – Phase 1	✓	✓
PA10	Single Flash 75 – Phase 2	✓	
PA11	Double Flash 150 – Phase 1	✓	✓
PA12	Double Flash 150 – Phase 2	✓	
PA13	Double Flash 75 – Phase 1	✓	✓
PA14	Double Flash 75 – Phase 2	✓	
PA15	Comet Flash 75		-
PA16	Action Flash	-	-
PA17	Module Flash	-	-
PA18	Comet Alert		-
PA19	Action Scan	-	-
PA20	Single Alert	-	-
PA21	Steady – High	N/A	N/A
PA22	Steady – Low	N/A	N/A
PA23	Off	N/A	N/A

Warranty

Your Agriweld Weight Block is covered for a period of 12 months from the date of dispatch (which is recorded on our files) against faulty components and/or bad workmanship.

Our welders are coded to ISO 9606-1 and our welding procedures are approved in accordance with ISO 15614-1 to manufacture your equipment. All products are checked for quality prior to delivery/collection.







We cannot be responsible for claims arising from ignorance, occurrences outside our control, such as accidents, and malicious damage and non-compliance with safety instructions.

Any damage occurred during transit must be reported on signing for the item from the haulier to enable us to enter a claim for damages direct with the haulier.

WARRANTY CLAIMS FOR DAMAGE DURING TRANSIT

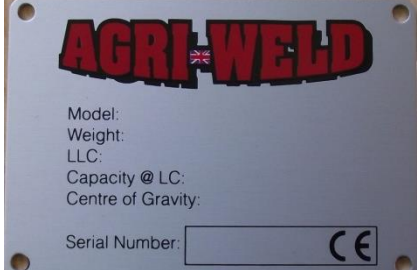
Damage occurred during transit via an external haulier must be reported immediately upon unloading and signing for the item. The limit of our liability to undertake repairs to products damaged during transit is dependent on signing for any damaged product upon delivery as "DAMAGED".

Stickers

Sticker	Part number	Description	Quantity per Machine
 <p>AGRI WELD AGRICULTURAL MACHINERY MANUFACTURERS 01377 259140 www.agriweld.co.uk</p>	AW_WB_AS (185 mm x 85mm)	Agriweld Sticker	3
 <p>Made Great In Britain</p>	AW_WB_GB (85mm x 50mm)	Great Britain Sticker	3
 <p>AGRI WELD</p> <p>Model: Weight: LLC: Capacity @ LC: Centre of Gravity:</p> <p>Serial Number: <input type="text"/> </p>	Serial plate (76mmX51mm)	Serial plate	1
 <p>AGRI WELD</p>	AW_WB_CHEV (300mmX300mm)	Chevron	2
 <p>ADD ANTI-FREEZE OR DRAIN IN WINTER</p> <p>AGRI WELD</p>	AW_WB_VW (100mmX80mm)	Water Variweight	1

CE DECLARATION OF CONFORMITY

The equipment which accompanies this declaration is in conformity with EU Directive(s):-

2006/42/EC Machinery Directive

Manufacturer Name:	Agriweld Ltd
Manufacturer Address:	Main Street Garton-on-the-Wolds Driffield East Yorkshire YO25 3ET
Product:	Weight Block 1000kg – 2500kg
Product Options:	All
Individual Serial Number:	
Product Description:	Agriweld Weight adds 1000kg – 2500kg to the tractor front end and assists in utilising the full power of the tractor whilst in the field and balances the tractor whilst moving heavy loads on the road.
Date of Last Load Test Report:	
Supplementary Information:	
Authorised Signatory on Behalf of Manufacturer:	
Name of Signatory:	Dawn Foster
Position in Company:	Director
Date of Issue:	